

Article number: 3902150010245

Description: Worm gear
VF 150-A-10-112B5, without lubrication

Measures

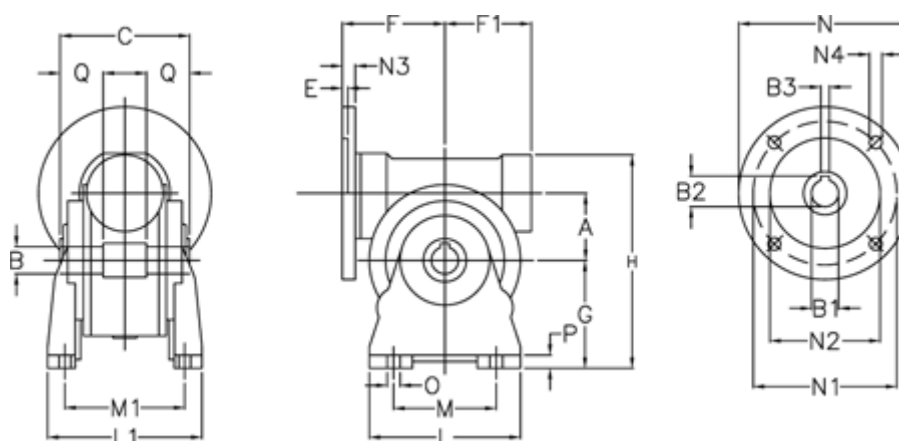

A	= 150	F1	= 179	N1	= 215
B	= 50 H7	G	= 220	N2	= 180
B1 E7	= 28	H	= 400	N3	= 11
B2	= 31.3	L	= 330	N4	= 13
B3 H9	= 8	L1	= 260	O	= 18
C	= 175	M	= 240	P	= 20
E	= 2	M1	= 211	Q	= 55
F	= 190	N	= 250		